

Flow Measurement

SITRANS F M

Battery-operated water meter MAG 8000

Overview



MAG 8000 is a comprehensive meter which intelligent information and high performance measurement as well as the easy to install concept take cost of ownership and customer service to a new level for water meter.

Benefits

Easy to install

- Compact or remote solution with factory mounted cable and customer setting from factory
- IP68/NEMA 6P enclosure. Sensor can be buried
- Flexible power supply - internal or external battery pack or mains power supply with battery back-up possibilities
- Superior measurement
- Down to 0.2 % maximum uncertainty
- OIML R 49 type approval
- PTB K7.2
- FM Fire Service Approval
- Bi-directional measurement

Long lasting performance/Low cost of Ownership

- Verification according to Directive 2004/22/EC of the European Parliament and Council of March 31, 2004 on measuring instruments (MID), Annex MI-001
- No moving parts means less wear and tear
- Up to 6 to 10 years maintenance-free operation in typical revenue application
- Robust construction build for the application

Intelligent information, easy to access

- Advanced information on site
- Data logger
- Advanced statistics and diagnostics
- Add-on communication modules

Application

The following MAG 8000 versions are available as stand-alone water meters:

- MAG 8000 (7ME6810) for abstraction and distribution network
- MAG 8000 CT (7ME6820) for revenue and bulk metering
- MAG 8000 (7ME6880) for irrigation

Design

MAG 8000 is designed to minimize power consumption. The product program consists of

- Basic and advanced version
- Sensor sizes from DN 25 to 1200 (1" to 48")
- Compact and remote installation in IP68/NEMA 6P enclosure and factory-mounted cable
- SIMATIC PDM and Flow Tool PC configuration softwares

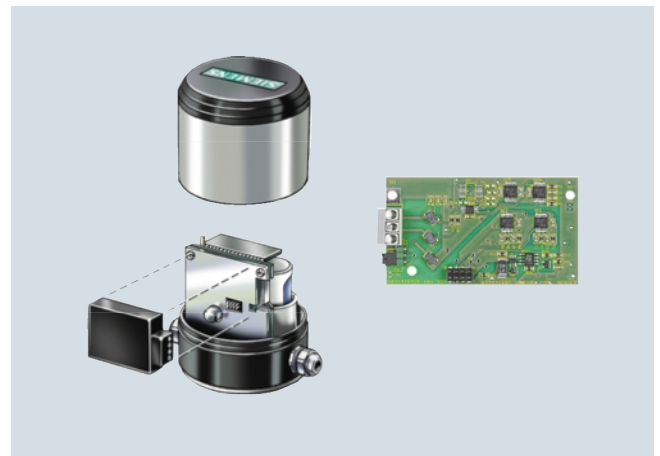
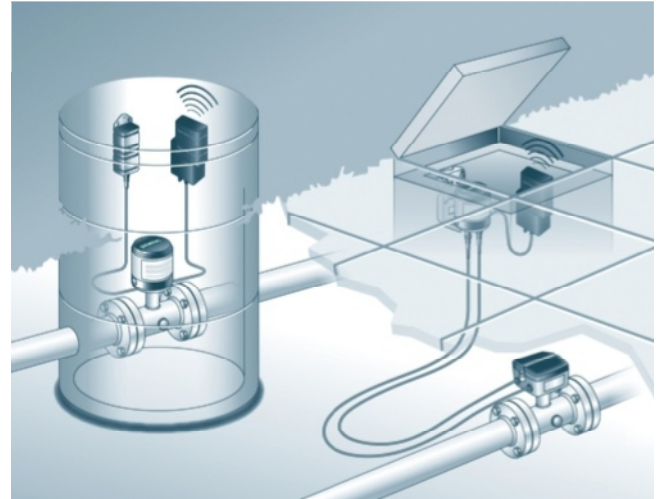

Modbus/Encoder module

Battery-operated water meter MAG 8000

MAG 8000 GSM/GPRS Wireless Communication Module

The MAG 8000 GSM/GPRS wireless communication module provides the latest mobile technology using a Quad Band (850/900/1800/1900 MHz) module.

The GSM/GPRS module logs data from the MAG 8000 memory and from the two analog inputs (one 4 to 20 mA not powered by the module and one 5 V ratiometric powered by the module) and storage in the internal memory and later transmit it into a system or PC via email or SMS.

An additional synchronization function secures the initial collection time of the data independent of the sample rate used (minimum collection time: 1 per minute).

The package of information retrieved via the csv file includes:

- Time stamp
- Flow rate
- Tot 1
- Tot 2
- Tot 3
- Analog 1 (mA)
- Analog 2 (V)
- Battery lifetime
- Alarm list (as decimal format)

The GPRS technology makes it possible to send a higher amount of data via email. The data is secured using a POP 3 server configuration avoiding encryptions that require additional software. The configuration of the module is performed via SMS commands that allow you to define the users, email accounts, transmission settings, collection, etc.

The GSM/GPRS module is a compact built-in solution which can be installed in the existing MAG 8000 with SW version 3.02 and higher.

The battery lifetime will depend on signal strength and especially on the number of transmissions. Therefore we recommend an optimal setting of transmission once a day (see page 3/119). The module also includes the same power management algorithm that secures a very good calculation of the remaining battery lifetime.

The OPC server specifically designed for the MAG 8000 GSM/GPRS module is offered free of charge. With this value-added package, the opportunity for measurement data collection and further processing/analyzing for system integration and automation is offered.

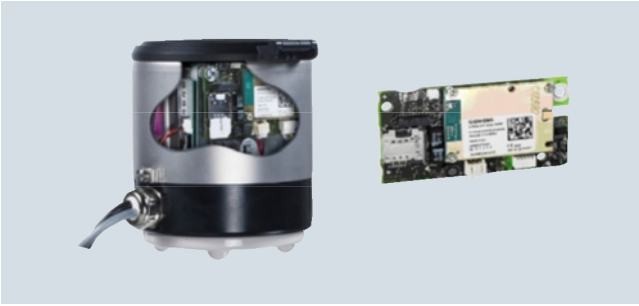

GSM/GPRS communication module



PC-IrDA connection

Flow Measurement

SITRANS FM

Battery-operated water meter MAG 8000

Function

MAG 8000 is a microprocessor-based water meter with graphical display and key for optimum customer operation and information on site. The transmitter drives the magnetic field in the sensor, evaluates the flow signal from the sensor and calculates the volume passing through. It delivers the required information via the integrated pulse output or communication interfaces as part of a system solution. Its intelligent functionality, information and diagnostics ensure optimum meter performance and information to optimize water supply and billing.



MAG 8000 can be ordered as a Basic or an Advanced version.

Features / Version	MAG 8000 Basic/ MAG 8000 Irrigation	MAG 8000 Advanced
Measuring frequency in battery power mode (Manually selected)	1/15, 1/30 or 1/60 Hz	from 6.25 to 1/60 Hz depending of sensor size
Output MAG 8000	2 FW/RV/AI/CA (max. 50 Hz pulse rate)	2 FW/RV/AI/CA (max. 100 Hz pulse rate)
Communication	Add-on	Add-on
Data logger	Yes	Yes
Insulation test	No	Yes
Leakage detection	No	Yes
Meter utilization	No	Yes
Statistics	No	Yes
Tariff	No	Yes
Settle date (Revenue)	No	Yes

Some information is accessible via the display whereas all information is accessible via the IrDA communication interface with the PDM software. Data and parameters are registered in a EEPROM. They can all be read, but changing the information demands a software password or a hardware key attached to the printed circuit board.

The SIMATIC PDM tool gives the possibility of testing and verifying the flowmeter on site and creating a printed "Qualification Certificate" with all specific data that define the quality status of the measurement.

The Qualification Certificate consists of two pages with information about the actual status of the sensor:

Part 1 provides general settings, sensor and battery info, totalizer values and pulse output settings.

Part 2 provides detailed information about electronic and sensor functionality and a main parameter list for evaluating the functionality of the MAG 8000 water meter.



SIMATIC PDM

Details about the SIMATIC PDM tool can be found in chapter "Communication and Software" (see page 8/11).

Technical specifications

Transmitter	
Installation	Compact (integral) Remote with factory-mounted cable 5, 10, 20 or 30 m (16.4, 32.8, 65.6 or 98.4 ft)
Enclosure	Stainl. steel top housing (AISI 316) and coated brass bottom. Remote wall mount bracket in stainless steel (AISI 304).
Cable entries	2 x M20 (one gland for one cable of size 6 ... 8 mm (0.02 ... 0.026 ft) is included in the standard delivery)
Display	Display with 8 digits for main information. Index, menu and status symbols for dedicated information
Resolution	Totalized information can be displayed with 1, 2 or 3 decimals or automatic adjustment (default)
Flow unit	
Europe	Volume in m ³ and flow rate in m ³ /h
US	Volume in Gallon and flow rate in GPM
Australia	Volume in MI and flow rate as MI/d
Optional display units	Volume: m ³ x 100, l x 100, G x 100, G x 1000, MG, CF x 100, CF x 1000, AF, Al, kl Flow: m ³ /min, m ³ /d, l/s, l/min, GPS, GPH, GPD, MGD, CFS, CFM, CFH
Digital output	2 passive outputs (MOS), individual galvanically isolated Maximum load ± 35 V DC, 50 mA short circuit protected
Output A function	Programmable as pulse volume – forward – reverse – forward/net – reverse/net
Output B function	Programmable as pulse volume (like output A), alarm
Output	Max. pulse rate of 50 Hz (only Basic version) and 100 Hz (only Advanced version), pulse width of 5, 10, 50, 100, 500 ms
Communication	IrDA: Standard integrated infrared communication interface with Modbus RTU protocol
Add-on modules	<ul style="list-style-type: none"> • RS 232 serial interface with Modbus RTU (Rx/Tx/GND), point to point with max. 15 m cable • RS 485 serial interface with Modbus RTU (+/-GND), multidrop with up to 32 devices with max. 1000 m cable • Encoder interface module (for Itron 200WP) "Sensus protocol" • GSM/GPRS module with or without analog input cable
Power supply	Auto detection of power source with display symbol for operation power.
Internal battery pack	1 D-Cell 3.6 V/16.5 Ah
External battery pack	2 D-Cell 3.6 V/33 Ah 4 D-Cell 3.6 V/66 Ah

Mains power supply

- 12 ... 24 V AC/DC (10 ... 32 V) 2 VA
- 115 ... 230 V AC (85 ... 264 V) 2 VA

Both mains power supply systems are upgradable for battery backup via internal D-Cell (3.6 V 16.5 Ah) or external battery pack.

Cable

3 m (9.8 ft) for external connection to mains supply (without cable plug)

Flow Measurement

SITRANS F M

Battery-operated water meter MAG 8000

Features	
Application identification	Tag number up to 15 characters
Time and date	Real time clock
Totalizer	
MAG 8000	3 totalizer: Configurable to Forward, Reverse and Bidirectional netflow 1 totalizer (following totalizer 1 setting) resettable via display key
Measurement	
Low flow cut-off	0.05 % of Q3 free adjustable
Empty pipe detection	Symbolised in display
Data logger	Logging of 26 records: selectable as daily, weekly or monthly logging
Alarm	Active alarm is indicated on the display
Data protection	All data stored in an EEPROM. Totalizers 1 and 2 are backed up every 10 min, statistic every hour and power consumption and temperature measurement every 4 hour. Password protection of all parameters and hardware protection of calibration and revenue parameters.
Battery power management	Optimal battery information on remaining capacity. Calculated capacity includes all consuming elements and available battery capacity is adjusted related to change in ambient temperature. Numbers of power-ups Date and time registered for first and last time power alarm.
Diagnostic	
Continuous self test including	Coil current to drive the magnetic field Signal input circuit Data calculation, handling and storing
Alarm statistics and logging for fault analyzing	Electrode impedance to check actual media contact Flow simulation to check pulse and communication signal chain for correct scaling Number of sensor measurements (excitations) Transmitter temperature (battery capacity calculation) Low impedance alarm for change in media Flow alarm when defined high flow exceeds Verification mode for fast measure performance check

Insulation test (only Advanced version)	Test of signal immunity against disturbance and bad installation. Test interval is selectable and measurement is interrupted during the test period of 4 min.
Leakage detection (only Advanced version)	Monitoring the lowest flow or volume during selected time window within 24 hours. Leakage is detected over a selectable period where monitored value exceed the possible leakage level. Min and max values are stored with date registration. Last store value visible on the display.
Meter Utilization (only Advanced version)	6 registers for monitoring total time the meter has operated in different flow intervals. Registered intervals are free selectable as % of Q _n (Q3)
Tariff (only Advanced version)	6 tariff registers count the volume delivered within the selected tariff windows, based on time of day or flow rates or a combination. Tariff can also be used for consumption profile where consumption is related to different time intervals or flow rates. Tariff values visible on the display.
Settling date (only Advanced version)	On a predefined date the totalizer 1 index value is stored. Old values are stored to show the latest two totalized 1 index values. Settling values visible on the display.
Statistic (only Advanced version)	Min. flow rate with time and date registration Max. flow rate with time and date registration Min. daily consumption with date registration Max. daily consumption with date registration Latest 7 days total and daily consumption Actual month consumption Latest month consumption
PC Configuration Software PDM	<ul style="list-style-type: none"> • Meter configuration – online and offline mode • Own parameter settings • Parameter documentation • Print and export of data and parameters PDM 6.0 Service Pack 2 – Basic and Online version

Flow Measurement SITRANS F M

Battery-operated water meter MAG 8000

MAG 8000 water meter uncertainty

To ensure continuous accurate measurement, flowmeters must be calibrated. The calibration is conducted at Siemens flow facilities with traceable instruments referring directly to the physical unit of measurement according to the International System of Units (SI).

Therefore, the calibration certificate ensures recognition of the test results worldwide, including the US (NIST traceability).

Siemens offers accredited calibrations assured to ISO 17025 in the flow range from 0.0001 m³/h to 10 000 m³/h. Siemens Flow Instruments accredited laboratories are recognized by ILAC MRA (International Laboratory Accreditation Corporation - Mutual Recognition Arrangement) ensuring international traceability and recognition of the test results worldwide.

The selected calibration determines the accuracy of the meter. A standard calibration results in max. ± 0.4 % uncertainty and an extended calibration ± 0.2 % (for MAG 8000 irrigation ± 0.8 %). A calibration certificate follows every sensor and calibration data are stored in the meter unit.

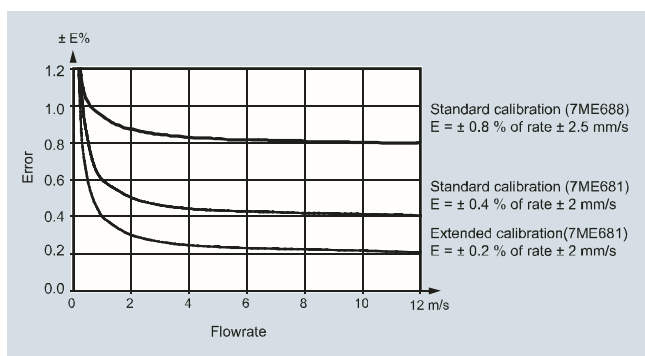

MAG 8000 (7ME6810) for Fire Service applications

MAG 8000 (7ME6810) is FM Fire Service approved for automatic fire protection systems according to the Fire Service Meters Standard, Class Number 1044. The approval is applicable for the sizes DN 50, DN 80, DN 100, DN 150, DN 200, DN 250, and DN 300 (2", 3", 4", 6", 8", 10", and 12") with ANSI B16.5 Class 150 flanges. The FM Fire Service approved product can be ordered via the Z-options P20, P21 and P22

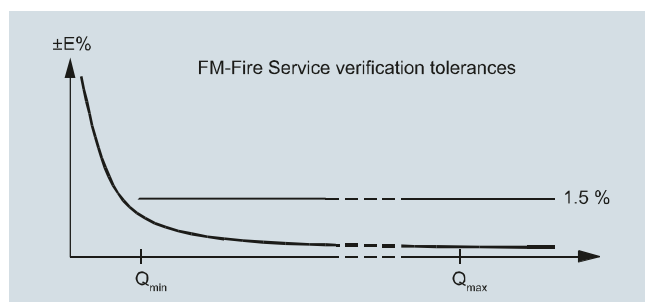

Grounding

The sensor body must be grounded using grounding straps and/or grounding rings to protect the flow signal against stray electrical noise. This ensures that the noise is carried through the sensor body and a noise-free measuring area within the sensor body. For MAG 8000 Irrigation grounding rings on both sides are factory-mounted.

<p>M6 x 16</p> <p>Metal pipe Metal pipe</p>	<p>Metal pipes</p> <p>On metal pipes, connect the straps to both flanges.</p>
<p>Plastic pipe Plastic pipe</p>	<p>Plastic pipes</p> <p>On plastic pipes and lined metal pipes, optional grounding rings must be used at both ends.</p> <p>Grounding rings has to be ordered separately see „Grounding ring kit“</p>
<p>M6 x 16</p> <p>Metal pipe Plastic pipe</p>	<p>Combination of metal and plastic pipes</p> <p>A combination of metal and plastic requires straps for metal pipe and grounding rings for plastic pipe.</p>

Battery operation time and calculation

The battery operation time depends on the connected battery pack as well as the operation condition of the meter.

MAG 8000 calculates the remaining capacity every 4 hours and includes all consuming elements. Calculation compensates for temperature influence on battery capacity.

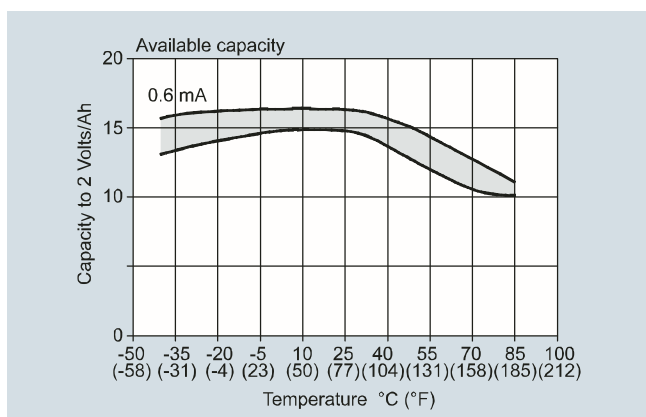

The graphic shows the effect from other temperatures. A variation in temperature from 15 °C to 55 °C (59 to 131 °F) reduces the capacity by 17% from 15 Ah to 12.5 Ah.

At typical revenue scenario of expected battery operation time can be seen in the table below.

The measurement for calculating the rest capacity of the battery life time is only completed if the system has no active fatal faults or the empty pipe is active. Maximum battery specification is 10 years operation.

Flow Measurement

SITRANS FM

Battery-operated water meter MAG 8000

Scenario - Revenue application

Output A	Pulse rate max. 10 Hz
Output B	Alarm or call-up
Meter dialog	1 hour per month
Add-com	None
Temperature	<ul style="list-style-type: none"> • 5 % at 0 °C (32 °F) • 80 % at 15 °C (59 °F) • 15 % at 50 °C (122 °F)

Battery lifetime (subject to the assumptions mentioned above)

MAG 8000 for abstraction and distribution network applications (7ME6810) and MAG 8000 CT for revenue and bulk metering (7ME6820)

Excitation frequency (24 h operation)		1/60 Hz	1/30 Hz	1/15 Hz	1/5 Hz	1.5625 Hz	3.125 Hz	6.25 Hz
2 D-Cell battery 33 Ah Internal battery pack	DN 25 ... 200 (1" ... 8")	8 years	8 years	6 years	40 months	8 months	4 months	2 months
	DN 250 ... 600 (10" ... 24")	8 years	6 years	4 years	20 months	4 months	2 months	N/A
	DN 700 ... 1 200 (28" ... 48")	6 years	4 years	2 years	1 year	2 months	N/A	N/A
4 D-Cell battery 66 Ah External battery pack	DN 25 ... 200 (1" ... 8")	N/A	10 years	10 years	80 months	16 months	8 months	4 months
	DN 250 ... 600 (10" ... 24")	N/A	10 years	10 years	40 months	8 months	4 months	N/A
	DN 700 ... 1 200 (28" ... 48")	10 years	8 years	4 years	2 years	4 months	N/A	N/A

MAG 8000 for irrigation applications (7ME6880)

Excitation frequency (24 h operation)		1/60 Hz	1/30 Hz	1/15 Hz	1/5 Hz	1.5625 Hz	3.125 Hz
1 D-Cell battery	DN 50 ... 600 (2" ... 24")	52 months	40 months	25 months	12 months	2 months	1 months
2 D-Cell battery 33 Ah Internal battery pack	DN 50 ... 600 (2" ... 24")	8 years	80 months	50 months	24 months	4 months	2 months
4 D-Cell battery 66 Ah Internal battery pack	DN 50 ... 600 (2" ... 24")	10 years	10 years	8 years	48 months	8 months	4 months

MAG 8000 GSM/GPRS battery lifetime scenario

Transmission once a day and MAG 8000 factory settings

2 D-Cell battery 33 Ah Internal battery pack	3 years
4 D-Cell battery 66 Ah Internal battery pack	7 years

External battery pack can be used as battery backup for mains power supply (if two cable entries in one cable gland are needed, order cable glands with two entries, see accessories on page 3/137).

Serial RS 232/RS 485 add-on communication modules are designed for mains powered systems as the battery operation time will be reduced. At 1 hour communication per month (all meter data collected 2 times per day) and the module is connected, the operation time is reduced to:

- RS 232 at low excitation frequency to 10 % and at high excitation frequency to 80 % of calculated operation time
- RS 485 at low excitation frequency to 50 % and at high excitation frequency to 90 % of calculated operation time

Flow Measurement

SITRANS F M

MAG 8000 for abstraction and distribution network applications (7ME6810)

Overview



Benefits

Easy to install

- Compact or remote solution with factory mounted cable and customer setting from factory
- IP68/NEMA 6P enclosure. Sensor can be buried.
- Flexible power supply - internal or external battery pack or mains power supply with battery back-up possibilities

Long-term stability/Low cost of ownership

- No moving parts in a robust construction means less wear and tear
- Basic and advanced transmitter versions with different optional add-on communication modules fulfil various customer requirements for high cost efficiency
- Up to 0.2 % maximum uncertainty
- Bi-directional measurement with an outstanding low flow performance
- Up to 10 years maintenance-free operation in typical applications

Intelligent information, easy to access

- Advanced information on site
- Advanced statistics and diagnostics
- Optional high-performance GSM/GPRS module offers an efficient solution for remote measurement and monitor via wireless communication.

Technical specifications

Meter	
Accuracy	Standard calibration: ± 0.4 % of rate ± 2 mm/s Extended calibration DN 50 ... DN 300 (2" ... 12"): ± 0.2 % of rate ± 2 mm/s
Media conductivity	Clean water > 20 µs/cm
Temperature	
Ambient	-20 ... +60 °C (-4 ... +140 °F)
Media	0 ... 70 °C (32 ... 158 °F)
Storage	-40 ... +70 °C (-40 ... +158 °F)
Enclosure rating	IP68/NEMA 6P (factory-mounted cable also provides IP68/NEMA 6P)
Certificates and approvals	
Calibration (standard)	2 x 25 % and 2 x 90 % (default)
Drinking water approvals	<ul style="list-style-type: none"> • NSF/ANSI Standard 61¹⁾ (cold water) USA • WRAS (BS 6920 cold water) UK • ACS Listed France • DVGW W270 Germany • Belgaqua (B) • MCERTS (GB)
Fire Service Approvals	FM Fire Service Meter (Class Number 1044)
Conformity	<ul style="list-style-type: none"> • PED: 97/23EC²⁾ <p>For pressure/temperature curves see MAG 3100 on page 3/70.</p> <ul style="list-style-type: none"> • EMC: IEC/EN 61326
Sensor version	DN 25 ... 1200 (1" ... 48")
Measuring principle	Electromagnetic induction
Excitation frequency	
Basic version	
• Battery-powered	DN 25 ... 150 (1" ... 6"): 1/15 Hz DN 200 ... 600 (8" ... 24"): 1/30 Hz DN 700 ... 1200 (28" ... 48"): 1/60 Hz
• Mains-powered	DN 25 ... 150 (1" ... 6"): 6.25 Hz DN 200 ... 600 (8" ... 24"): 3.125 Hz DN 700 ... 1200 (28" ... 48"): 1.5625 Hz

Flow Measurement

SITRANS F M

MAG 8000 for abstraction and distribution network applications (7ME6810)

Advanced version	
• Battery-powered	DN 25 ... 150 (1" ... 6"): 1/15 Hz (adjustable up to 6.25 Hz; reduced battery lifetime) DN 200 ... 600 (8" ... 24"): 1/30 Hz (adjustable up to 3.125 Hz; reduced battery lifetime) DN 700 ... 1200 (28" ... 48"): 1/60 Hz (adjustable up to 1.5625 Hz; reduced battery lifetime)
• Mains-powered	DN 25 ... 150 (1" ... 6"): 6.25 Hz DN 200 ... 600 (8" ... 24"): 3.125 Hz DN 700 ... 1200 (28" ... 48"): 1.5625 Hz
Flanges	
EN 1092-1 (DIN 2501)	DN 25 and DN 40 (1" and 1½"): PN 40 (580 psi) DN 50 ... 150 (2" ... 6"): PN 16 (232 psi) DN 200 ... 1200 (8" ... 48"): PN 10 or PN 16 (145 psi or 232 psi)
ANSI 16.5 Class 150	1" ... 24": 20 bar (290 psi)
AWWA C-207	28" ... 48": PN 10 (145 psi)
AS 4087	DN 50 ... 1200 (2" ... 48"): PN 16 (232 psi)
Liner	EPDM
Electrode and grounding electrodes	Hastelloy C276/2.4819
Grounding straps	Grounding straps are premounted from the factory on each side of the sensor.

1) Including Annex G

2) For further information on the PED standard and requirements see page 9/6.

Flow Measurement SITRANS F M

MAG 8000 for abstraction and distribution network applications (7ME6810)

3

Selection and Ordering data	Article No.
SITRANS F M MAG 8000 water meter	7 ME 6 8 1 0 -
Diameter	
DN 25 (1")	2 D
DN 40 (1½")	2 R
DN 50 (2")	2 Y
DN 65 (2½")	3 F
DN 80 (3")	3 M
DN 100 (4")	3 T
DN 125 (5")	4 B
DN 150 (6")	4 H
DN 200 (8")	4 P
DN 250 (10")	4 V
DN 300 (12")	5 D
DN 350 (14")	5 K
DN 400 (16")	5 R
DN 450 (18")	5 Y
DN 500 (20")	6 F
DN 600 (24")	6 P
DN 700 (28") ¹⁾	6 Y
DN 750 (30") ¹⁾	7 D
DN 800 (32") ¹⁾	7 H
DN 900 (36") ¹⁾	7 M
DN 1000 (40") ¹⁾	7 R
DN 1050 (42") ¹⁾	7 U
DN 1100 (44") ¹⁾	7 V
DN 1200 (48") ¹⁾	8 B
Flange norm and pressure rating	
EN 1092-1	B
PN 10 (DN 200 ... 1200 (8" ... 48"))	C
PN 16 (DN 50 ... 1200 (2" ... 48"))	D
PN 16 non-PED (DN 700 ... 1200 (28"... 48"))	F
PN 40 (DN 25 ... 40 (1" ... 1½"))	J
ANSI B16.5	L
Class 150	N
AWWA C-207	
Class D (28" ... 48")	
AS4087	
PN 16 (DN 50 ... 1200 (2" ... 48"))	
Sensor version	
EPDM liner and Hastelloy electrodes	3
Calibration	
Standard ± 0.4 % of rate ± 2 mm/s	1
Extended ± 0.2 % of rate ± 2 mm/s DN 25... 300 (1" ... 12")	2
Region version	
Europe (m ³ , m ³ /h, 50 Hz)	1
USA (Gallon, GPM, 60 Hz)	2
Australia (Ml, Ml/d, 50 Hz)	3
Transmitter type and installation	
Basic version integral on sensor	A
Basic version remote, cable mounted on sensor with IP68/NEMA 6P plugs:	
• 5 m (16.4 ft)	B
• 10 m (32.8 ft)	C
• 20 m (65.6 ft)	D
• 30 m (98.4 ft)	E
Advanced version integral on sensor	K
Advanced version remote, cable mounted on sensor with IP68/NEMA 6P plugs:	
• 5 m (16.4 ft)	L
• 10 m (32.8 ft)	M
• 20 m (65.6 ft)	N
• 30 m (98.4 ft)	P

Selection and Ordering data	Article No.
SITRANS F M MAG 8000 water meter	7 ME 6 8 1 0 -
Communication interface	
No additional "add-on" communication module installed	A
Serial RS 485 with Modbus RTU (Terminated as end device)	B
Serial RS 232 with Modbus RTU	C
GSM/GPRS communication module with remote antenna; 5 m (16.4 ft) cable	S
GSM/GPRS communication module with analog inputs and remote antenna; 5 m (16.4 ft) cable	T
Power supply	
Internal battery (no battery included)	0
Internal battery pack installed ²⁾	1
Power cable (1.5 m (4.9 ft)) with IP68/NEMA 6P plugs for external battery (no battery included)	2
12/24 V AC/DC power supply with battery backup and 3 m (9.8 ft) power cable for external connection (no battery included)	3
115 ... 230 V AC power supply with battery backup and 3 m (9.8 ft) power cable for external connection (no battery included)	4

- The Diameter DN 700 (28") to DN 1200 (48") is only available as remote transmitter type installation.
- Lithium batteries are subject to special transportation regulations according to United Nations "Regulation of Dangerous Goods, UN 3090 and UN 3091". Special transport documentation is required to observe these regulations. This may influence both transport time and costs.

• We can offer shorter delivery times for configurations designated with the Quick Ship Symbol . For details see page 9/5 in the appendix.

Operating instructions for SITRANS F M MAG 8000

Description	Article No.
• English	A5E03071515
• German	A5E00740986
• Spanish	A5E00741031
• French	A5E00741021

This device is shipped with a Quick Start guide and a CD containing further SITRANS F literature.

All literature is also available for free at:
<http://www.siemens.com/flowdocumentation>

Operating instructions for MAG 8000 GSM/GPRS communication module

Description	Article No.
• English	A5E03644134

Flow Measurement

SITRANS F M

MAG 8000 for abstraction and distribution network applications (7ME6810)

Selection and Ordering data	Order code
Additional information	
Please add "-Z" to Article No. and specify Order code(s) and plain text.	
Flow unit	
l/s	L00
MGD	L01
CFS	L02
l/min	L03
m ³ /min	L04
GPM	L05
CFM	L06
l/h	L07
m ³ /h	L08
GPH	L09
CFH	L10
GPS	L11
MI/d	L12
m ³ /d	L13
GPD	L14
Totalizer	
Volume calculation (default totalizer 1= forward and totalizer 2 = reverse)	
Totalizer 1 = RV, reverse flow	L20
Totalizer 1 = NET, net flow	L22
Totalizer 2 = FW, forward flow	L30
Totalizer 2 = NET, net flow	L31
Volume unit	
m ³	L40
MI	L41
G	L42
AF	L43
l x 100	L44
m ³ x 100	L45
G x 100	L46
CF x 100	L47
MG	L48
G x 1000	L49
CF x 1000	L50
Al	L51
kl	L52
Pulse set up (default pulse A= forward and pulse B = Alarm)	
A function = RV, reverse flow	L62
A function = FWnet, forward net flow	L63
A function = RVnet, reverse net flow	L64
A function = Off	L65
Volume per pulse A = x 0.0001	L70
Volume per pulse A = x 0.001	L71
Volume per pulse A = x 0.01	L72
Volume per pulse A = x 0.1	L73
Volume per pulse A = x 1	L74
B function = FW, forward flow	L80
B function = RV, verse flow	L81
B function = FWnet, forward net flow	L82
B function = RVnet, reverse net flow	L83
B function = Alarm	L84
B function = Call up	L85
Volume per pulse B = x 0.0001	L90
Volume per pulse B = x 0.001	L91
Volume per pulse B = x 0.01	L92
Volume per pulse B = x 0.1	L93
Volume per pulse B = x 1	L94

Selection and Ordering data	Order code
Additional information	
Please add "-Z" to Article No. and specify Order code(s) and plain text.	
Data logger set up (default month logging)	
DataloggerInterval = Daily	M31
DataloggerInterval = Weekly	M32
Factory mounted cables	
5 m (16.4 ft) pulse cable A+B	M81
5 m (16.4 ft) communication cable RS 232/RS 485 terminated as end device	M82
20 m (65.6 ft) pulse cable A+B	M84
20 m (65.6 ft) communication cable RS 232/RS 485 terminated as end device	M85
Cello 2 channel, input cable 3 m (9.84 ft) with Brad Harrison micro-change 3 way connector	M87
Cello 2 channel, input cable 5 m (16.4 ft) with MIL-C-26482 spec. connectors	M89
SOFREL data logger cable 2 m with connector for SOFREL GSM module	M92
FM Fire Service Approval (with ANSI B16.5 Class 150 flanges)	
DN 50, DN 80 and DN 100 (2", 3" and 4")	P20
DN 150 and DN 200 (6" and 8")	P21
DN 250 and DN 300 (10" and 12")	P22

Flow Measurement

SITRANS F M

MAG 8000 CT for revenue and bulk metering
(7ME6820)

Overview



Benefits

Approvals

- MI-001, OIML R 49/OIML R 49 MAA
- PTB K7.2
- FM Fire Service

Easy to install

- Compact or remote solution with factory mounted cable and customer setting from factory
- IP68/NEMA 6P enclosure. Sensor can be buried
- Flexible power supply - internal or external battery pack or mains power supply with battery back-up possibilities

Long-term stability/Low cost of ownership

- No moving parts in a robust construction means less wear and tear
- Basic and advanced transmitter versions with different optional add-on communication modules fulfil various customer requirements for high cost efficiency
- Bi-directional measurement with an outstanding low flow performance
- Up to 10 years maintenance-free operation in typical applications
- Insignificant pressure drop

Intelligent information, easy to access

- Advanced information on site
- Advanced statistics and diagnostics
- Connectable to common AMR systems

Technical specifications

Meter	
Accuracy	OIML R 49/OIML R 49 MAA for DN 50 ... DN 300 (2" ... 12"), Class I and II with turn down up to Q3/Q1 = 400 at Q2/Q1 = 1.6 MI-001 verification for DN 50 ... DN 400 (2" ... 16"), Class II with turn down ratio Q3/Q1 = 250, Q3/Q1 = 200 or Q3/Q1 = 160 at Q2/Q1 = 1.6 FM Fire Service for DN 50, DN 80, DN 100, DN 150, DN 200, DN 250, and DN 300 (2", 3", 4", 6", 8", 10", and 12") ± 1,5% (Q _{min} to Q _{max})
Media conductivity	Clean water > 20 µs/cm
Temperature	
Ambient	-20 ... +60 °C (-4 ... +140 °F) MI-001: -25 ... +55 °C (-13 ... +131 °F)
Media	0.1 ... 50 °C (32 ... 122 °F)
Storage	-40 ... +70 °C (-22 ... +158 °F)
Enclosure rating	IP68/NEMA 6P Cable glands mounted requires Sylgard potting kit to remain IP68/NEMA 6P, otherwise IP67/NEMA 4 is obtained; Factory-mounted cable provides IP68/NEMA 6P
Certificates and approvals	
Calibration (standard)	2 x 25 % and 2 x 90 %
Drinking water approvals	<ul style="list-style-type: none"> • NSF/ANSI Standard 61¹⁾ (cold water) USA • WRAS (BS 6920 cold water) UK • ACS Listed France • DVGW W270 Germany • Belgaqua (B) • MCERTS (GB)
Fire Service approval	FM Fire Service (1044)
Custody transfer approval	<ul style="list-style-type: none"> • OIML R 49 and OIML R 49 MAA approval (DN 50 ... DN 300 (2" ... 12")) • MI-001 approval (DN 50 ... DN 400 (2" ... 16")) (Number: DK-0200-MI-001-002 and DK-0200-MI-001-011)
Conformity	<ul style="list-style-type: none"> • CEN EN 14154, ISO 4064 • PED: 97/23/EC²⁾ For pressure/temperature curves, see MAG 3100 on page 3/70. <ul style="list-style-type: none"> • EMC: IEC/EN 61326
Sensor version	DN 50 ... 600 (2" ... 24")
Measuring principle	Electromagnetic induction
Excitation frequency	
Basic version	
• Battery-powered	DN 50 ... 150 (2" ... 6"): 1/15 Hz DN 200 ... 600 (8" ... 24"): 1/30 Hz
• Mains-powered	DN 50 ... 150 (2" ... 6"): 6.25 Hz DN 200 ... 600 (8" ... 24"): 3.125 Hz
Advanced version	
• Battery-powered	DN 50 ... 150 (2" ... 6"): 1/15 Hz (adjustable up to 6.25 Hz; reduced battery lifetime) DN 200 ... 600 (8" ... 24"): 1/30 Hz (adjustable up to 3.125 Hz; reduced battery lifetime)
• Mains-powered	DN 50 ... 150 (2" ... 6"): 6.25 Hz DN 200 ... 600 (8" ... 24"): 3.125 Hz

Flow Measurement

SITRANS F M

MAG 8000 CT for revenue and bulk metering (7ME6820)

Flanges	
EN 1092-1 (DIN 2501)	DN 50 ... 150 (2" ... 6"): PN 16 (232 psi) DN 200 ... 300 (8" ... 12"): PN 10 or PN 16 (145 psi or 232 psi) up to DN 600 (24") in preparation
ANSI 16.5 Class 150	2" ... 12": 20 bar (290 psi) up to DN 600 (24") in preparation
AWWA C-207 AS 4087	28" ... 48": PN 10 (145 psi) DN 50 ... 300 (2" ... 12"): PN 16 (232 psi) up to DN 600 (24") in preparation
Liner	EPDM
Electrode and grounding electrodes	Hastelloy C276/2.4819
Grounding straps	Grounding straps are premounted from the factory on each side of the sensor

¹⁾ Including Annex G

²⁾ For further information on the PED standard and requirements see page 9/6.

MAG 8000 CT (Revenue program) water meter type approval

MAG 8000 CT program is type approved and verified according to international water meter standard OIML R 49. The Custody Transfer program is approved as Class I and Class II, for the sensor program from DN 50 to DN 300, at different Q3 and Q3/Q1. Q2/Q1 = 1.6 and follows OIML R 49 specification.

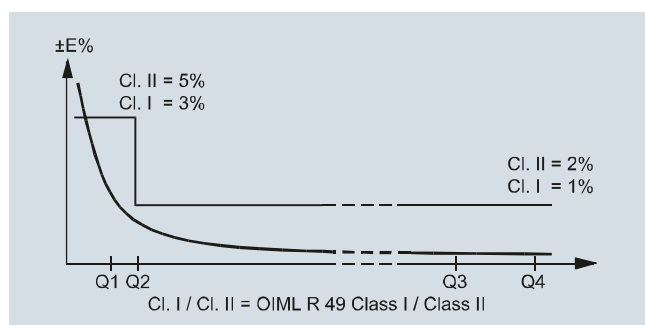

OIML R 49/2006-DK2-10.01 Revision 1 approval specification for Class I (1 %) ¹⁾

Size	DN 50 (2")	DN 65 (2½")	DN 80 (3")	DN 100 (4")	DN 125 (5")	DN 150 (6")	DN 200 (8")	DN 250 (10")	DN 300 (12")	DN 350 (14")	DN 400 (16")	DN 450 (18")	DN 500 (20")	DN 600 (24")
„R“ Q3/Q1	250	250	250	250	250	250	250	250	125	-	-	-	-	-
Q1 [m ³ /h]	0.25	0.40	0.63	1.00	1.60	2.50	4.00	6.40	12.8	-	-	-	-	-
Q2 [m ³ /h]	0.40	0.64	1.00	1.60	2.60	4.00	6.40	10.24	20.48	-	-	-	-	-
Q3 [m³/h]	63	100	160	250	400	630	1000	1600	1600	-	-	-	-	-
Q4 [m ³ /h]	78.75	125	200	312.5	500	787.5	1250	2000	2000	-	-	-	-	-

OIML R 49/2006-DK2-10.01 Revision 1 approval specification for Class II (2 %) ¹⁾

Size	DN 50 (2")	DN 65 (2½")	DN 80 (3")	DN 100 (4")	DN 125 (5")	DN 150 (6")	DN 200 (8")	DN 250 (10")	DN 300 (12")	DN 350 (14")	DN 400 (16")	DN 450 (18")	DN 500 (20")	DN 600 (24")
„R“ Q3/Q1	400	400	400	400	400	400	400	400	200	-	-	-	-	-
Q1 [m ³ /h]	0.16	0.25	0.40	0.63	1.00	1.60	2.50	4.00	10.00	-	-	-	-	-
Q2 [m ³ /h]	0.25	0.40	0.63	1.00	1.60	2.50	4.00	6.40	16.00	-	-	-	-	-
Q3 [m³/h]	63	100	160	250	400	630	1000	1600	1600	-	-	-	-	-
Q4 [m ³ /h]	78.75	125	200	312.5	500	787.5	1250	2000	2000	-	-	-	-	-

¹⁾ The product will be delivered according to requested specifications, which may deviate from the specifications of the approval frame described in tables below.

MAG 8000 CT (Revenue program) MI-001

MAG 8000 CT program is type approved according to international water meter standard OIML R 49. Since the first November 2006 the MI-001 water meter directive is in force, which means that all water meters can be sold across the EU borders if the water meters contain a MI-001 label.

The MAG 8000 CT MI-001 verified and labeled products are a Class II approval according to Directive 2004/22/EC of the European Parliament and Council of March 31, 2004 on measuring instruments (MID), Annex MI-001 in the sizes from DN 50 to DN 400.

The MID certification is obtained as a B + D module approval according to the above mentioned directive.

Module B : Type approval according to OIML R 49

Module D : Quality insurance approval of production

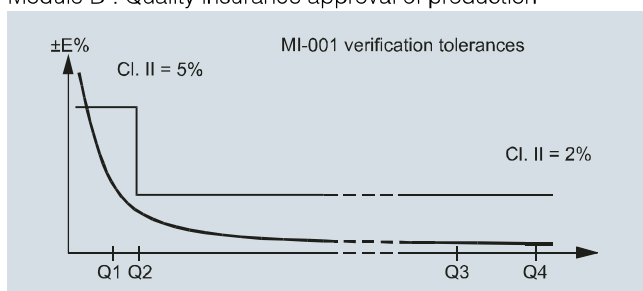

MAG 8000 CT MI-001 verified and labeled products at a given Q3 and Q4/Q3 = 1.25 and Q2/Q1 = 1.6 measuring ranges see below table:

7ME6820-xxxx1	DN 50 (2")	DN 65 (2½")	DN 80 (3")	DN 100 (4")	DN 125 (5")	DN 150 (6")	DN 200 (8")	DN 250 (10")	DN 300 (12")	DN 350 (14")	DN 400 (16")	DN 450 (18")	DN 500 (20")	DN 600 (24")
„R“ Q3/Q1	25	25	25	25	25	25	25	25	25	25	25	-	-	-
Q4 [m³/h]	20	31.25	50	78.75	125	200	312.5	500	750	1250	1250	-	-	-
Q3 [m³/h]	16	25	40	63	100	160	250	400	630	1000	1000	-	-	-
Q2 [m³/h]	0.96	1.60	2.60	4.03	6.40	10.24	16	25.60	38.4	64	64	-	-	-
Q1 [m³/h]	0.60	1	1.60	2.52	4	6.40	10	16	24	40	40	-	-	-

7ME6820-xxxx2	DN 50 (2")	DN 65 (2½")	DN 80 (3")	DN 100 (4")	DN 125 (5")	DN 150 (6")	DN 200 (8")	DN 250 (10")	DN 300 (12")	DN 350 (14")	DN 400 (16")	DN 450 (18")	DN 500 (20")	DN 600 (24")
„R“ Q3/Q1	63	63	63	63	63	63	63	63	63	63	63	-	-	-
Q4 [m³/h]	20	31.25	50	78.75	125	200	312.5	500	750	1250	1250	-	-	-
Q3 [m³/h]	16	25	40	63	100	160	250	400	630	1000	1000	-	-	-
Q2 [m³/h]	0.41	0.63	1.02	1.60	2.54	4.06	6.35	10.16	16	25.4	25.4	-	-	-
Q1 [m³/h]	0.25	0.40	0.63	1	1.59	2.54	3.97	6.35	10	15.9	15.9	-	-	-

7ME6820-xxxx3	DN 50 (2")	DN 65 (2½")	DN 80 (3")	DN 100 (4")	DN 125 (5")	DN 150 (6")	DN 200 (8")	DN 250 (10")	DN 300 (12")	DN 350 (14")	DN 400 (16")	DN 450 (18")	DN 500 (20")	DN 600 (24")
„R“ Q3/Q1	80	80	80	80	80	80	80	80	80	80	80	-	-	-
Q4 [m³/h]	20	31.25	50	78.75	125	200	312.5	500	750	1250	1250	-	-	-
Q3 [m³/h]	16	25	40	63	100	160	250	400	630	1000	1000	-	-	-
Q2 [m³/h]	0.32	0.50	0.80	1.20	2	3.20	5	8	12.6	20	20	-	-	-
Q1 [m³/h]	0.20	0.31	0.50	0.75	1.25	2	3.13	5	7.88	12.5	12.5	-	-	-

7ME6820-xxxx4	DN 50 (2")	DN 65 (2½")	DN 80 (3")	DN 100 (4")	DN 125 (5")	DN 150 (6")	DN 200 (8")	DN 250 (10")	DN 300 (12")	DN 350 (14")	DN 400 (16")	DN 450 (18")	DN 500 (20")	DN 600 (24")
„R“ Q3/Q1	160	160	160	160	160	160	160	160	160	160	160	-	-	-
Q4 [m³/h]	50	78.75	125	200	312.5	500	787.5	1250	2000	2000	2000	-	-	-
Q3 [m³/h]	40	63	100	160	250	400	630	1000	1600	1600	1600	-	-	-
Q2 [m³/h]	0.40	0.63	1	1.60	2.50	4	6.30	10	16	16	16	-	-	-
Q1 [m³/h]	0.25	0.39	0.63	1	1.56	2.50	3.94	6.25	10	10	10	-	-	-

7ME6820-xxxx5	DN 50 (2")	DN 65 (2½")	DN 80 (3")	DN 100 (4")	DN 125 (5")	DN 150 (6")	DN 200 (8")	DN 250 (10")	DN 300 (12")	DN 350 (14")	DN 400 (16")	DN 450 (18")	DN 500 (20")	DN 600 (24")
„R“ Q3/Q1	200	200	200	200	200	200	200	200	200	200	-	-	-	-
Q4 [m³/h]	50	78.75	125	200	312.5	500	787.5	1250	2000	2000	2000	-	-	-
Q3 [m³/h]	40	63	100	160	250	400	630	1000	1600	1600	1600	-	-	-
Q2 [m³/h]	0.32	0.50	0.80	1.28	2	3.20	5.04	8	12.80	12.80	-	-	-	-
Q1 [m³/h]	0.20	0.32	0.50	0.80	1.25	2	3.15	5	8	8	-	-	-	-

Flow Measurement

SITRANS F M

MAG 8000 CT for revenue and bulk metering (7ME6820)

7ME6820-xxxx6	DN 50 (2")	DN 65 (2½")	DN 80 (3")	DN 100 (4")	DN 125 (5")	DN 150 (6")	DN 200 (8")	DN 250 (10")	DN 300 (12")	DN 350 (14")	DN 400 (16")	DN 450 (18")	DN 500 (20")	DN 600 (24")
„R“ Q3/Q1	250	250	250	250	250	250	250	250	250	-	-	-	-	-
Q4 [m³/h]	50	78.75	125	200	312.5	500	787.5	1250	2000	-	-	-	-	-
Q3 [m³/h]	40	63	100	160	250	400	630	1000	1600	-	-	-	-	-
Q2 [m³/h]	0.26	0.40	0.64	1.02	1.60	2.56	4	6.40	10.24	-	-	-	-	-
Q1 [m³/h]	0.16	0.25	0.40	0.64	1	1.60	2.52	4	6.40	-	-	-	-	-

The Label is placed on the side of the encapsulation. An example of the product label is shown below:

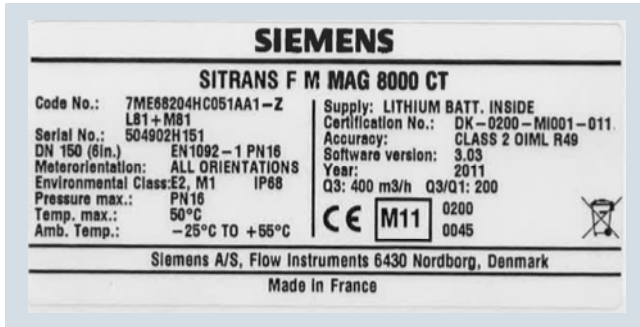

Installation conditions

Please refer to "System information SITRANS F M electromagnetic flowmeters".

Battery operation time and calculation

The battery operation time depends on the connected battery pack as well as the operation condition of the meter.

MAG 8000 calculates the remaining capacity every 4 hours and includes all consuming elements. Calculation compensates for temperature influence on battery capacity (drawing).

MAG 8000 CT (7ME6820) for Fire Service applications

MAG 8000 CT (7ME6820) is FM Fire Service approved for automatic fire protection systems according to the Fire Service Meters Standard, Class Number 1044. The approval is applicable for the sizes DN 50, DN 80, DN 100, DN 150, DN 200, DN 250, and DN 300 (2", 3", 4", 6", 8", 10", and 12") with ANSI B16.5 Class 150 flanges. The FM Fire Service approved product can be ordered via the Z-options P20, P21 and P22.

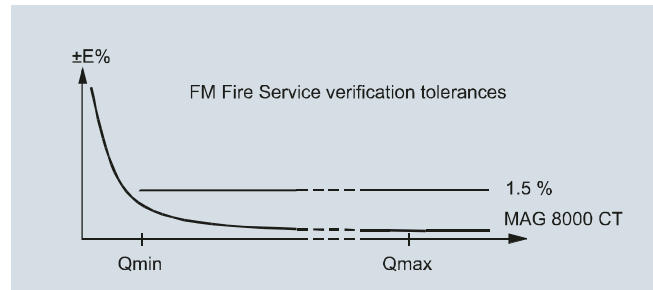

Flow Measurement SITRANS F M

MAG 8000 CT for revenue and bulk metering (7ME6820)

3

Selection and Ordering data	Article No.
SITRANS F M	
MAG 8000 CT water meter with EPDM liner and Hastelloy electrodes	7 ME 6 8 2 0 -
	0 -
Diameter	
DN 50 (2")	2 Y
DN 65 (2½")	3 F
DN 80 (3")	3 M
DN 100 (4")	3 T
DN 125 (5")	4 B
DN 150 (6")	4 H
DN 200 (8")	4 P
DN 250 (10")	4 V
DN 300 (12")	5 D
DN 350 (14")	5 K
DN 400 (16")	5 R
DN 450 (18") ¹⁾	5 Y
DN 500 (20") ¹⁾	6 F
DN 600 (24") ¹⁾	6 P
Flange norm and pressure rating	
<u>EN 1092-1</u>	
PN 16	C
<u>ANSI B16.5</u>	
Class 150	J
<u>AS4087</u>	
PN 16	N
Approval/Verification³⁾	
Without verification according to OIML R 49 ⁴⁾	0
MI-001 Q3/Q1 = 25	1
MI-001 Q3/Q1 = 63	2
MI-001 Q3/Q1 = 80	3
MI-001 Q3/Q1 = 160	4
MI-001 Q3/Q1 = 200	5
MI-001 Q3/Q1 = 250	6
Without verification calibrated to OIML R 49-Class II (Q3/Q1 = 100)	7
Without verification calibrated to OIML R 49-Class II (Q3/Q1 = 250)	8
Region version	
Europe (m ³ , m ³ /h, 50 Hz)	1
USA (m ³ , m ³ /h, 60 Hz)	2
Transmitter type and installation	
Basic version integral on sensor	A
Basic version remote, 5 m (16.4 ft) mounted cable on sensor with IP68/NEMA 6P plugs	B
Do - 10 m (32.8 ft)	C
Do - 20 m (65.6 ft)	D
Do - 30 m (98.4 ft)	E
Advanced version integral on sensor	K
Advanced version remote, 5 m mounted cable on sensor with IP68/NEMA 6P plugs	L
Do - 10 m (32.8 ft)	M
Do - 20 m (65.6 ft)	N
Do - 30 m (98.4 ft)	P

Selection and Ordering data	Article No.
SITRANS F M	
MAG 8000 CT water meter with EPDM liner and Hastelloy electrodes	7 ME 6 8 2 0 -
	0 -
Communication interface	
No additional "add-on" communication module installed	A
Serial RS 485 with Modbus RTU (Terminated as end device)	B
Serial RS 232 with Modbus RTU	C
Encoder interface for ITRON 200WP radio with "Sensus" protocol"	D
GSM/GPRS module without analog inputs cable	S
GSM/GPRS module with analog inputs cable	T
Power supply	
Internal battery (no battery included)	0
Internal battery pack installed ²⁾	1
Power cable (1.5 m (4.9 ft)) with IP68/NEMA 6P plugs for external battery (no battery included)	2
12/24 V AC/DC power supply with battery backup and 3 m (9.8 ft) power cable for external connection (no battery included)	3
115 ... 230 V AC power supply with battery backup and 3 m (9.8 ft) power cable for external connection. (no battery included)	4
¹⁾ Under preparation. ²⁾ Lithium batteries are subject to special transportation regulations according to United Nations "Regulation of Dangerous Goods, UN 3090 and UN 3091". Special transport documentation is required to observe these regulations. This may influence both transport time and costs. ³⁾ For more details and references of the ranges please see the tables on pages 3/126 to 3/128. ⁴⁾ Standard calibration or according to FM Fire Service requirements if P20, P21 or P22 is selected as Z option.	

Operating instructions for SITRANS F M MAG 8000

Description	Article No.
English	A5E03071515
German	A5E00740986
Spanish	A5E00741031
French	A5E00741021

This device is shipped with a Quick Start guide and a CD containing further SITRANS F literature.

All literature is also available for free at:
<http://www.siemens.com/flowdocumentation>

Operating instructions for MAG 8000 GSM/GPRS communication module

Description	Article No.
English	A5E03644134

Flow Measurement

SITRANS F M

MAG 8000 CT for revenue and bulk metering (7ME6820)

Selection and Ordering data Order code

Additional information

Please add "-Z" to Article No. and specify Order code(s) and plain text.

FP2E marking (France only)

C17

Totalizer

Volume calculation (default totalizer 1 = forward and totalizer 2 = reverse)

Totalizer 1 = RV, reverse flow

L20

Totalizer 1 = NET, net flow

L22

Totalizer 2 = FW, forward flow

L30

Totalizer 2 = NET, net flow

L31

Pulse set up

(default pulse A = forward and pulse B = Alarm)

A function = RV, reverse flow

L62

A function = FWnet, forward net flow

L63

A function = RVnet, reverse net flow

L64

A function = Off

L65

Volume per pulse A = x 0.001

L71

Volume per pulse A = x 0.01

L72

Volume per pulse A = x 0.1

L73

Volume per pulse A = x 1

L74

B function = FW, forward flow

L80

B function = RV, reverse flow

L81

B function = FWnet, forward net flow

L82

B function = RVnet, reverse net flow

L83

B function = Alarm

L84

B function = Call up

L85

Volume per pulse B = x 0.001

L91

Volume per pulse B = x 0.01

L92

Volume per pulse B = x 0.1

L93

Volume per pulse B = x 1

L94

Data logger set up (default month logging)

DataloggerInterval = Daily

M31

DataloggerInterval = Weekly

M32

Factory mounted cables

5 m (16.4 ft) pulse cable A+B

M81

5 m (16.4 ft) communication cable RS 232/RS 485 terminated as end device

M82

20 m (65.6 ft) pulse cable A+B

M84

20 m (65.6 ft) communication cable RS 232/RS 485 terminated as end device

M85

Cello 2 channel, input cable 3 m (9.84 ft) with Brad Harrison micro-change 3 way connector

M87

Cello 2 channel, input cable 5 m (16.4 ft) with MIL-C-26482 spec. connectors

M89

5 ft. Encoder interface cable with connector for ITRON 200WP radio

M91

25 ft. Encoder interface cable with connector for ITRON 200WP radio

M90

SOFREL data logger cable 2 m with connector for SOFREL GSM module

M92

FM Fire Service Approval

(with ANSI B16.5 Class 150 flanges)

DN 50, DN 80 and DN 100 (2", 3" and 4")

P20

DN 150 and DN 200 (6" and 8")

P21

DN 250 and DN 300 (10" and 12")

P22

Flow Measurement

SITRANS F M

MAG 8000 for irrigation applications
(7ME6880)

Overview



Benefits

- IP68/NEMA 6P rating with tamper proof
- Flexible power supply - internal or external battery pack or mains power supply with battery back-up possibilities
- No moving parts in a robust construction means less wear and tear
- Up to 8 years maintenance-free operation in typical application
- Connectable to AMR systems

Technical specifications

Meter	
Accuracy	± 0.8 % ± 2.5 mm/s
Media conductivity	Clean water > 20 µs/cm
Temperature	
Ambient	-20 ... +60 °C (-4 ... +140 °F)
Media	0 ... 70 °C (32 ... 158 °F)
Storage	-40 ... +70 °C (-40 ... +158 °F)
Enclosure rating	IP68/NEMA 6P rating (factory-mounted cable option also provides IP68/NEMA 6P)
Approvals	
Drinking water approvals	<ul style="list-style-type: none"> • ANSI/NSF 61¹⁾ (cold water) USA • WRAS (BS 6920 cold water) UK
Custody transfer approval	NMI10 Australia (under preparation)
Conformity	IEC/EN 61326
Flanges	
Drilled to:	
• EN 1092-1 (DIN 2501) PN 10	DN 50 ... 600 (2" ... 24") (max. pressure 7 bar (101.5 psi))
• ANSI 16.5 Class 150	2" ... 24" (max. pressure 7 bar (101.5 psi))
• AS 2091-1 Table D	DN 50 ... 600 (2" ... 24") (max. pressure 7 bar (101.5 psi))
Excitation frequency	
Battery-powered	DN 50 ... 600 (2" ... 24"): 1/15 Hz
Mains-powered	DN 50 ... 600 (2" ... 24"): 3.125 Hz
Liner	Ebonite
Electrodes	Stainless steel

¹⁾ Including Annex G

Flow Measurement

SITRANS F M

MAG 8000 for irrigation applications (7ME6880)

Selection and Ordering data	Article No.
SITRANS F M MAG 8000 water meter including factory-mounted grounding rings	7 ME 6 8 8 0 -
	0 -
Diameter	
DN 50 (2")	2 Y
DN 65 (2½")	3 F
DN 80 (3")	3 M
DN 100 (4")	3 T
DN 125 (5")	4 B
DN 150 (6")	4 H
DN 200 (8")	4 P
DN 250 (10")	4 V
DN 300 (12")	5 D
DN 350 (14")	5 K
DN 400 (16")	5 R
DN 450 (18")	5 Y
DN 500 (20")	6 F
DN 600 (24")	6 P
Flange norm and pressure rating	
EN 1092-1 drilled pattern PN 10/max. 7 bar (101 psi)	B
ANSI B16.5 drilled pattern CI 150/max. 7 bar (101 psi)	J
AS2129 drilled pattern table D/max. 7 bar (101 psi)	M
Sensor version	
Ebonite liner and stainless steel electrodes	4
Region version	
Europe (m ³ , m ³ /h, 50 Hz)	1
USA (Gallon, GPM, 60 Hz)	2
Australia (MI, MI/d, 50 Hz)	3
Transmitter type and installation	
Basic version integral on sensor	A
Basic version remote, 2 m (6.56 ft) mounted cable on sensor with IP68/NEMA 6P plugs	T
Do - 5 m (16.4 ft)	B
Do - 10 m (32.8 ft)	C

Selection and Ordering data	Article No.
SITRANS F M MAG 8000 water meter including factory-mounted grounding rings	7 ME 6 8 8 0 -
	0 -
Communication interface	
No additional "add-on" communication module installed	A
Serial RS 485 with Modbus RTU (Terminated as end device)	B
Serial RS 232 with Modbus RTU	C
Encoder interface	D
Power supply	
Internal battery (no battery included)	0
Internal battery pack installed 2 D-cell ^{1) 2)}	1
Power cable (1.5 m (4.9 ft)) with IP68/NEMA 6P plugs for external battery (no battery included)	2
12/24 V AC/DC power supply with battery backup and 3 m (9.8 ft) power cable for external connection (no battery included)	3
115 ... 230 V AC power supply with battery backup and 3 m (9.8 ft) power cable for external connection (no battery included)	4
Internal battery pack installed 1 D-cell ^{1) 2)}	5
¹⁾ Lithium batteries are subject to special transportation regulations according to United Nations "Regulation of Dangerous Goods, UN 3090 and UN 3091". Special transport documentation is required to observe these regulations. This may influence both transport time and costs. ²⁾ Can be ordered by US region only.	
Operating instructions for SITRANS F M MAG 8000	
Description	Article No.
• English	A5E03071515
• German	A5E00740986
• Spanish	A5E00741031
• French	A5E00741021
This device is shipped with a Quick Start guide and a CD containing further SITRANS F literature. All literature is also available for free at: http://www.siemens.com/flowdocumentation	

Flow Measurement

SITRANS F M

MAG 8000 for irrigation applications
(7ME6880)

3

Selection and Ordering data	Order code	Selection and Ordering data	Order code
Additional information		Additional information	
Please add "-Z" to Article No. and specify Order code(s) and plain text.		Please add "-Z" to Article No. and specify Order code(s) and plain text.	
<u>Flow unit</u>		<u>Data logger set up</u> (default month logging)	
l/s	L00	DataloggerInterval = Daily	M31
MGD	L01	DataloggerInterval = Weekly	M32
CFS	L02	<u>Factory mounted cables</u>	
l/min	L03	5 m (16.4 ft) pulse cable A+B	M81
m ³ /min	L04	5 m (16.4 ft) communication cable RS 232/RS 485 terminated as end device	M82
GPM	L05	20 m (65.6 ft) pulse cable A+B	M84
CFM	L06	20 m (65.6 ft) communication cable RS 232/RS 485 terminated as end device	M85
l/h	L07	Cello 2 channel, input cable 3 m (9.84 ft) with Brad Harrison micro-change 3 way connector	M87
m ³ /h	L08	Cello 2 channel, input cable 5 m (16.4 ft) with MIL-C-26482 spec. connectors	M89
GPH	L09	5 ft Encoder interface cable with connector for ITRON 200WP radio	M91
CFH	L10	25 ft Encoder interface cable with connector for ITRON 200WP radio	M90
GPS	L11	SOFREL data logger cable 2 m with connector for SOFREL GSM module	M92
MI/d	L12		
m ³ /d	L13		
GPD	L14		
<u>Totalizer</u>			
Volume calculation (default totalizer 1= forward and totalizer 2 = reverse)			
Totalizer 1 = RV, reverse flow	L20		
Totalizer 1 = NET, net flow	L22		
Totalizer 2 = FW, forward flow	L30		
Totalizer 2 = NET, net flow	L31		
<u>Volume unit</u>			
m ³	L40		
MI	L41		
G	L42		
AF	L43		
l x 100	L44		
m ³ x 100	L45		
G x 100	L46		
CF x 100	L47		
MG	L48		
G x 1000	L49		
CF x 1000	L50		
Al	L51		
kl	L52		
<u>Pulse set up</u>			
(default pulse A= forward and pulse B = Alarm)			
A function = RV, reverse flow	L62		
A function = FWnet, forward net flow	L63		
A function = RVnet, reverse net flow	L64		
A function = Off	L65		
Volume per pulse A = x 0.0001	L70		
Volume per pulse A = x 0.001	L71		
Volume per pulse A = x 0.01	L72		
Volume per pulse A = x 0.1	L73		
Volume per pulse A = x 1	L74		
B function = FW, forward flow	L80		
B function = RV, reverse flow	L81		
B function = FWnet, forward net flow	L82		
B function = RVnet, reverse net flow	L83		
B function = Alarm	L84		
B function = Call up	L85		
Volume per pulse B = x 0.0001	L90		
Volume per pulse B = x 0.001	L91		
Volume per pulse B = x 0.01	L92		
Volume per pulse B = x 0.1	L93		
Volume per pulse B = x 1	L94		

Flow Measurement SITRANS F M

Battery-operated water meter MAG 8000

Dimensional drawings

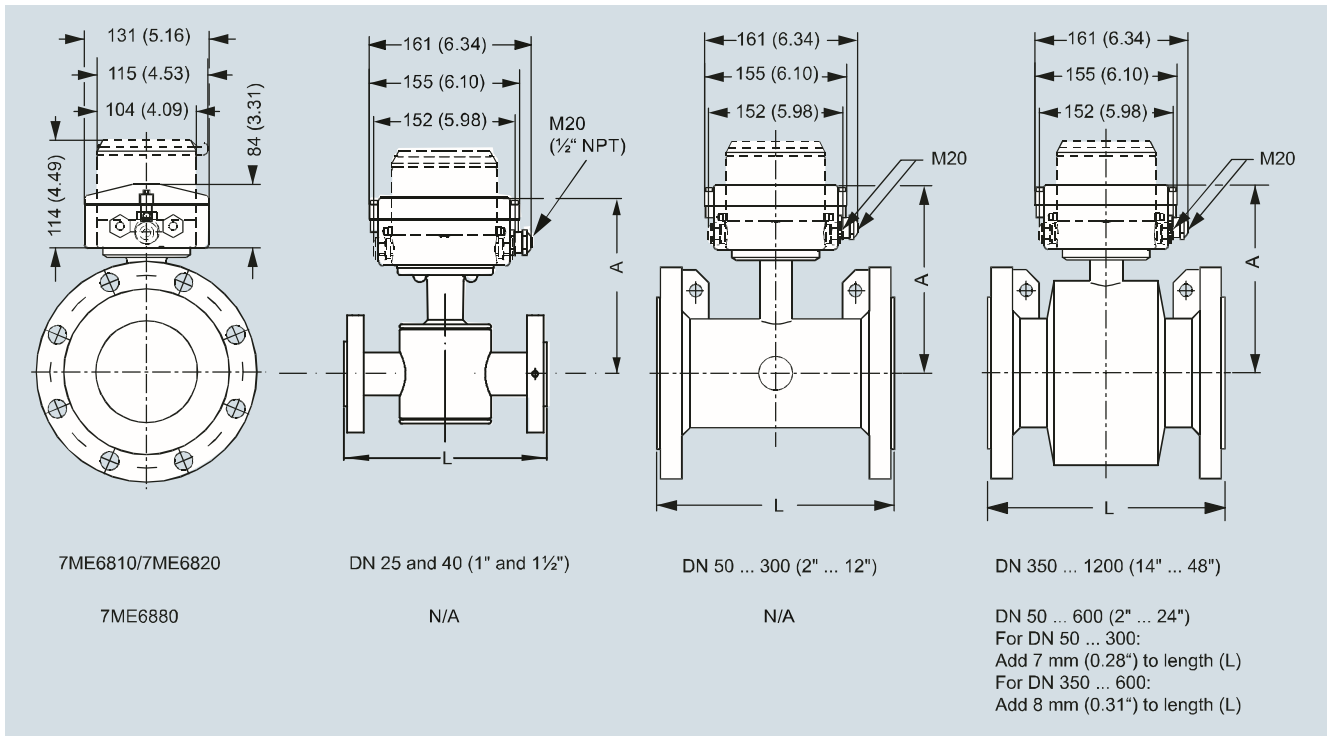

Dimensions in mm (inch)

Nominal DN size	A	L, lengths						Weight ¹⁾	
		EPDM (7ME6810 and 7ME6820)	EN 1092-1 PN 10	EN 1092-1 PN 16/ PN 16 non-PED	EN 1092-1 PN 40	ANSI 16.5 Class 150	AS 4087 PN 16	AWWA C-207 Class D	kg
mm (inch)	mm (inch)	mm	mm	mm	inch	mm	mm		
25 (1)	194 (7.7)	-	-	200	7.9	200	-	6	13
40 (1½)	204 (8.1)	-	-	200	7.9	200	-	9	20
50 (2)	195 (7.7)	-	200	-	7.9	200	-	11	25
65 (2½)	201 (8)	-	200	-	7.9	200	-	13	29
80 (3)	207 (8.2)	-	200	-	7.9	200	-	15	34
100 (4)	214 (8.5)	-	250	-	9.8	250	-	17	38
125 (5)	224 (8.9)	-	250	-	9.8	250	-	22	50
150 (6)	239 (9.5)	-	300	-	11.8	300	-	28	63
200 (8)	264 (10.5)	350	350	-	13.8	350	-	50	113
250 (10)	291 (11.5)	450	450	-	17.7	450	-	71	160
300 (12)	317 (12.6)	500	500	-	19.7	500	-	88	198
350 (14)	369 (14.6)	550	550	-	21.7	550	-	127	279
400 (16)	394 (15.6)	600	600	-	23.6	600	-	145	318
450 (18)	425 (16.8)	600	600	-	23.6	600	-	175	384
500 (20)	450 (17.8)	600	600	-	26.8	600	-	225	494
600 (24)	501 (19.8)	600	600	-	32.3	600	-	340	747
700 (28)	544 (21.4)	700	875/700	-	N/A	N/A	700	316	694
750 (30)	571 (22.5)	N/A	N/A	-	N/A	N/A	750	N/A	N/A
800 (32)	606 (23.9)	800	1000/800	-	N/A	N/A	800	398	1045
900 (36)	653 (25.7)	900	1125/900	-	N/A	N/A	900	476	1045
1000 (40)	704 (27.7)	1000	1250/1000	-	N/A	N/A	1000	602	1322
1050 (42)	704 (27.7)	N/A	N/A	-	N/A	N/A	1050	N/A	N/A
1100 (44)	755 (29.7)	N/A	N/A	-	N/A	N/A	1100	N/A	N/A
1200 (48)	810 (31.9)	1200	1500/1200	-	N/A	N/A	1200	887	1996

¹⁾ For remote version the sensor weight is reduced with 2 kg (4.5 lb)

Remote version

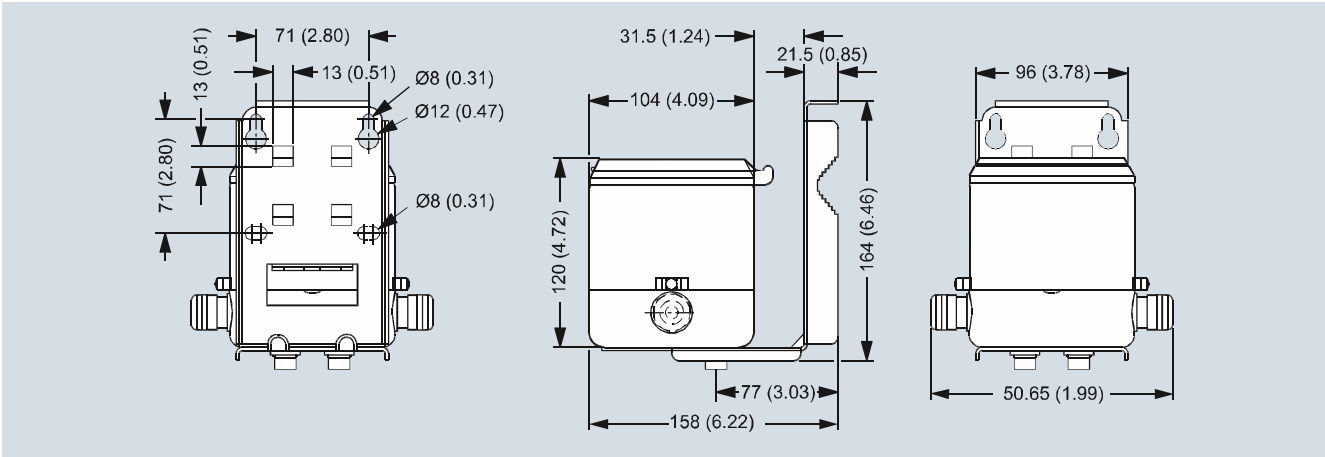

Dimensions in mm (inch), weight 3.5 kg (8 lb)

External battery pack

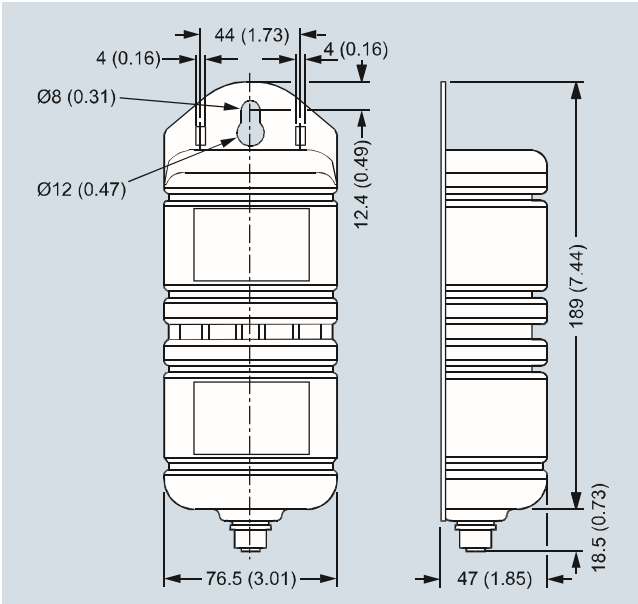

Dimensions in mm (inch), weight 2.0 kg (4.5 lb)

Battery pack has to be mounted in upwards position to ensure maximum battery capacity.

Grounding rings

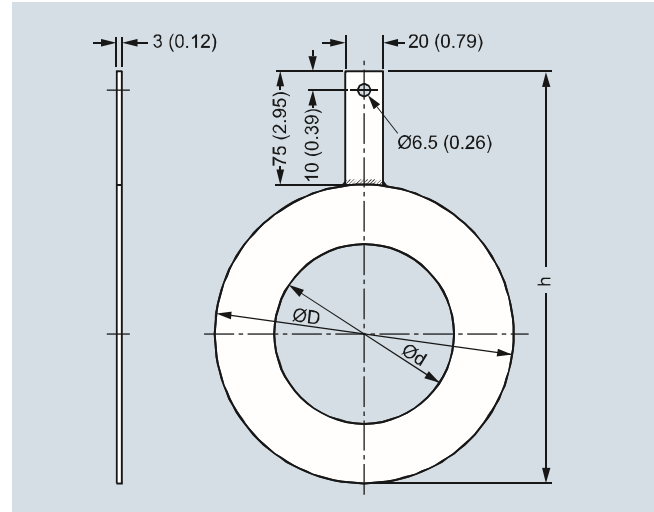

Dimensions in mm (inch) for grounding rings MAG 8000 with EPDM lining (7ME6810 and 7ME6820) DN 25 to DN 300

Dimension	Internal diameter (d)	Outside diameter (D)	h
DN 25	27	68	143
DN 40	38	88	163
DN 50	52	100	175
DN 65	64	120	195
DN 80	79	133	208
DN 100	95	158	233
DN 125	115	188	263
DN 150	145	216	336
DN 200	193	268	343
DN 250	246	324	399
DN 300	295	374	449

Flow Measurement SITRANS F M

Battery-operated water meter MAG 8000

Schematics

Electrical installation and pulse output – Connection diagram

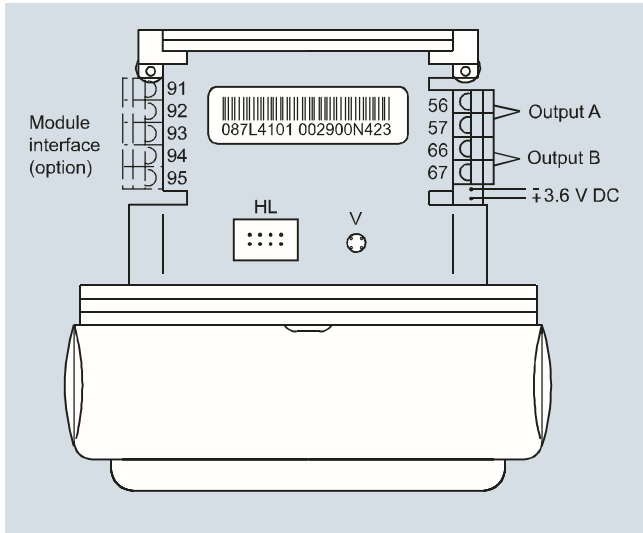

HL = Hardware lock key connection
V = Push button for verification mode

Pulse wire connection

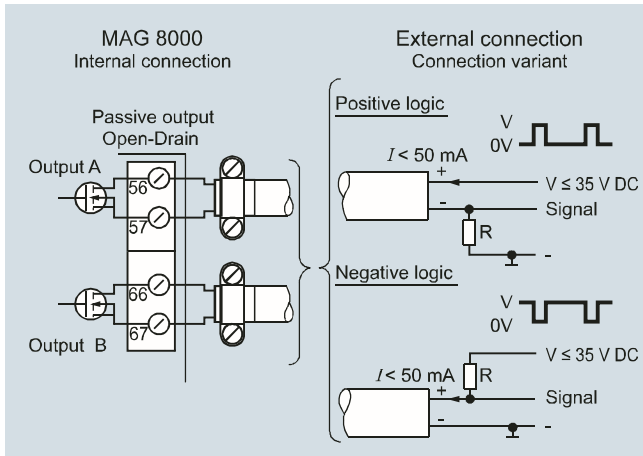

The pulse output can be configured as volume, alarm or call-up. The output can be connected as positive or negative logic. R = pull up/down is selected in relation to the Vx power supply and with a max. current I of 50 mA.

Use shielded cable to avoid EMC problems. Make sure the shield is correctly mounted under the cable clamp (no pig tail).



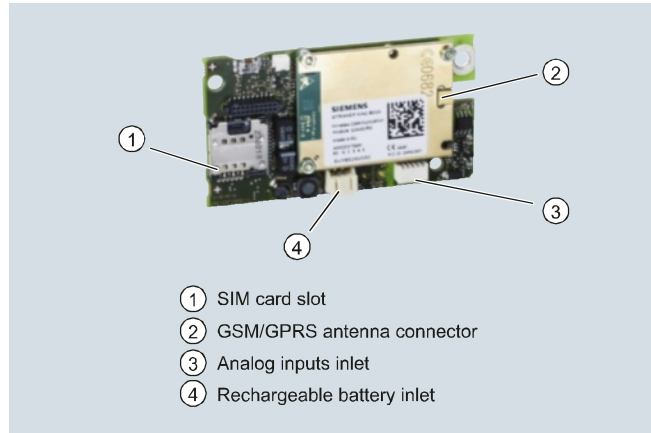





Electrical installation of GSM/GPRS module









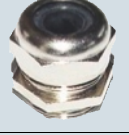

- ① SIM card slot
- ② GSM/GPRS antenna connector
- ③ Analog inputs inlet
- ④ Rechargeable battery inlet

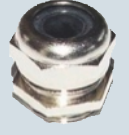
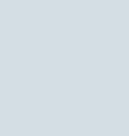
Battery-operated water meter MAG 8000

Accessories

Description	Article No.	
PC Flow Tool on CD (Download for free from www.siemens.com/flow)	FDK:087L6001	
IrDA infrared interface adapter with USB for data acquisition with 1.2 m (3.9 ft) cable	◆ FDK:087L4163	
Battery backup for mains power supply, 1 pc. D-cell (3.6 V, 16.5 Ah) ¹⁾	◆ A5E03354392	
Rechargeable Lithium battery for MAG 8000 GSM/GPRS communication module	◆ A5E03436686	
Internal battery pack, one set of 2 D-cell (3.6 V 33 Ah) and accessories for replacement ¹⁾	◆ FDK:087L4150	
External battery pack IP68/NEMA 6P with connector, 4 D-cell (3.6 V 66 Ah) ¹⁾ . Order cable FDK:087L4152 separately.	◆ FDK:087L4151	
Mains power supply 12 ... 24 V AC/DC (average power consumption during line ≤ 0.1 VA) with battery backup and 3 m (9.8 ft) power cable for external connection (no battery included) Temperature range: Fixed laying: -40 ... +90 °C (-40 ... +194 °F) Flexible application: -30 ... +80 °C (-22 ... +176 °F)	FDK:087L4210	
Mains power supply 115 ... 230 V AC, 50/60 Hz, with battery backup up and 3 m (9.8 ft) power cable for external connection (no battery included)	◆ FDK:087L4211	
RS 232 add-on module, point to point communication interface with Modbus RTU protocol	FDK:087L4212	
RS 485 add-on module, multidrop communication interface with Modbus RTU protocol	FDK:087L4213	
Encoder interface module, with "Sensus" protocol for ITRON 200WP and 100W radio, only for use with 7ME6820 and 7ME6880 routes	A5E02475650	

Description	Article No.	
MAG 8000 GSM/GPRS communication module. Rechargeable battery, antenna and analog cable input must be ordered separately	◆ A5E03412758	
One cable entry 6 ... 8 mm (0.24 ... 0.31 ") M20 brass glands package ²⁾ (1 pc)	◆ FDK:087L4196	
One cable entry 2 ... 5 mm (0.08 ... 0.20 ") M12 brass glands with M20 reduction ²⁾ . Package of 10 pcs	FDK:087L4154	
One cable entry 6 ... 8 mm (0.24 ... 0.31 ") M20 brass glands package ²⁾ (10 pcs)	FDK:087L4155	
One cable entry 8 ... 11 mm (0.31 ... 0.43 ") M20 brass glands package ²⁾ (10 pcs)	FDK:087L4156	
One cable entry 11 ... 15 mm (0.43 ... 0.59 ") M20 brass glands package ²⁾ (10 pcs)	FDK:087L4157	
Two cable entries 3.5 ... 5 mm (0.14 ... 0.20 ") M20 brass glands package ²⁾ (10 pcs)	FDK:087L4158	
Two cable entries 5.5 ... 7.5 mm (0.22 ... 0.30 ") M20 brass glands package ²⁾ (10 pcs)	FDK:087L4159	
High gain antenna for MAG 8000 GSM/GPRS (PVC, IP68, cable length 5 m (16.4 ft), with SMA male connector (type RG 58) and internal SMA to SMP female cable adapter, and single entry cable gland)	◆ A5E03436689	
Analog input cable for MAG 8000 GSM/GPRS (3 m (9.8 ft) cable with M12 connector A-Coding female 5 pins, and two-entry cable gland)	A5E03436698	
Potting kit for terminal box of flow sensors for IP68/NEMA 6P (not for Ex sensors)	◆ FDK:085U0220	
MAG 8000 Hardware key to access protected parameters	◆ FDK:087L4165	
MAG 8000 demo - training unit pack operating on Alkaline batteries. Transmitter with Flow tool CD, IrDA interface adapter and hardware key (No dangerous goods limitations)	FDK:087L4080	

Flow Measurement

SITRANS F M

Battery-operated water meter MAG 8000

3

Description	Article No.	
Alkaline battery for MAG 8000 demo transmitter (3 V 13 Ah) (No dangerous goods limitations)	FDK:087L4142	

◆ We can offer shorter delivery times for configurations designated with the Quick Ship Symbol ◆. For details see page 9/5 in the appendix.

1) Lithium batteries are subject to special transportation regulations according to United Nations "Regulation of Dangerous Goods, UN 3090 and UN 3091". Special transport documentation is required to observe these regulations. This may influence both transport time and costs.

2) For cable connection through MAG 8000 transmitter bottom part.



When MAG 8000 (7ME6810 and 7ME6820) is installed in PVC or coated pipelines, grounding rings must be installed additionally.







Grounding rings, type C must be used for the 7ME6810 and 7ME6820 routes (sizes > DN 300). Please see grounding rings in the section MAG 3100 Grounding rings and be aware that the mentioned MLFB codes include only 1 grounding ring. Grounding rings DN 25 to DN 300 in stainless steel are packed in pairs and sold as a "grounding ring kit".

Dimension	Article No.	
DN 25	◆ A5E01002946	
DN 40	◆ A5E01002947	
DN 50	◆ A5E01002948	
DN 65	A5E01002950	
DN 80	◆ A5E01002952	
DN 100	◆ A5E01002953	
DN 125	A5E01002954	
DN 150	◆ A5E01002955	
DN 200	A5E01002957	
DN 250	◆ A5E01002958	
DN 300	◆ A5E01002962	

We can offer shorter delivery times for configurations designated with the Quick Ship Symbol ◆. For details see page 9/5 in the appendix.

Spare parts

Description	Article No.	
MAG 8000 transmitter compact replacement kit ¹⁾ . No battery included. System number specified by ordering.	FDK:087L4166	
MAG 8000 transmitter remote replacement kit ¹⁾ . System number specified by ordering.	FDK:087L4202	
MAG 8000 (Advanced version) transmitter compact replacement kit ¹⁾ . No battery included. No system number required.	FDK:087L4203	

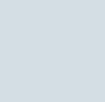
Description	Article No.	
MAG 8000 (Advanced version) transmitter remote replacement kit ¹⁾ . No battery included. No system number required.	FDK:087L4204	
MAG 8000 (Basic version) transmitter PCB replacement kit ¹⁾ . No system number required.	◆ A5E01171569	
MAG 8000 (Advanced version) transmitter PCB replacement kit ¹⁾ . No system number required.	FDK:087L4168	
Enclosure top including plastic lid, screws and blank product label	◆ FDK:087L4167	
Power cable (1.5 m (4.9 ft)) with IP68/NEMA 6P plugs for external battery (no battery included); PE jacket, ambient temperature: -20 ... +60 °C (-4 ... +140 °F)	◆ FDK:087L4152	
5 ft. Encoder interface cable with IP68/NEMA 6P plugs included, for ITRON 200WP and 100W radio; 22 AWG stranded TC conductors, polypropylene insulation, twisted pair, overall Beldfoil shield, 22 AWG stranded TC drain wire, PVC jacket	A5E02551263	
25 ft. Encoder interface cable with IP68/NEMA 6P plugs included, for ITRON 200WP radio; 22 AWG stranded TC conductors, polypropylene insulation, twisted pair, overall Beldfoil shield, 22 AWG stranded TC drain wire, PVC jacket	A5E02551182	

◆ We can offer shorter delivery times for configurations designated with the Quick Ship Symbol ◆. For details see page 9/5 in the appendix.

Flow Measurement SITRANS F M

Battery-operated water meter MAG 8000

Description	Article No.	
Service tool kit package with various component for service and replacement.	FDK:087L4162	
Remote cable set 5 m (16.4 ft) with IP68/NEMA 6P plugs - PG 13.5 ²⁾	FDK:087L4108	
Remote cable set 5 m (16.4 ft) with IP68/NEMA 6P plugs - M20	A5E00862482	
Remote cable set 10 m (32.8 ft) with IP68/NEMA 6P plugs - PG 13.5 ²⁾	FDK:087L4109	
Remote cable set 10 m (32.8 ft) with IP68/NEMA 6P plugs - M20	◆ A5E00862487	
Remote cable set 20 m (65.6 ft) with IP68/NEMA 6P plugs - PG 13.5 ²⁾	FDK:087L4110	
Remote cable set 20 m (65.6 ft) with IP68/NEMA 6P plugs - M20	A5E00862492	
Remote cable set 30 m (98.4 ft) with IP68/NEMA 6P plugs - PG 13.5 ²⁾	FDK:087L4111	
Remote cable set 30 m (98.4 ft) with IP68/NEMA 6P plugs - M20	A5E00862497	

MAG 8000 (7ME6880) grounding ring service kit, consisting of 2 pcs. grounding rings, screws and gaskets

Dimension	Article No.	
DN 50 2"	A5E03082907	
DN 65 2½"	A5E03082908	
DN 80 3"	A5E03082909	
DN 100 4"	A5E03082910	
DN 125 5"	A5E03082911	
DN 150 6"	A5E03082912	
DN 200 8"	A5E03082913	
DN 250 10"	A5E03082914	
DN 300 12"	A5E03082915	
DN 350 14"	A5E03082916	
DN 400 16"	A5E03082917	
DN 450 18"	A5E03082918	
DN 500 20"	A5E03082919	
DN 600 24"	A5E03082920	

1) Not applicable to Custody Transfer (CT) verified systems without re-verification
 2) For sensors produced before October 2007.